

POPPY FLOOR

serien
.lighting

serien Raumleuchten GmbH Hainhäuserstr. 3-7 D-63110 Rodgau
www.serien.com

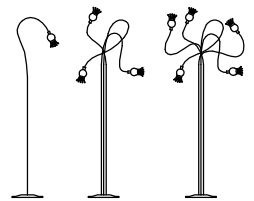

Design Becker, Soanca-Pollak, Thammer

D Vor Montage, Leuchtmittelwechsel und Reinigung, Leuchte vom Netz trennen!
Die Leuchte nur im Innenbereich einsetzen!

GB Prior to assembly, changing the lamp or cleaning the luminaire please detach it from the mains. Only use the luminaire indoors.

F Prière de couper le courant avant tout montage, changement d'ampoule et nettoyage. Ce luminaire est réservé à un usage en intérieur.

I Scollegare la lampada dalla rete elettrica prima del montaggio, della sostituzione del corpo illuminante e della pulizia. La lampada è adatta esclusivamente per interni.

E Antes de proceder al montaje, el cambio de bombilla y la limpieza desconecte la lámpara de la red eléctrica. Instale la lámpara sólo en un lugar interior.

NL Voor montage, vervanging en reiniging de lamp van het stroomnet loskoppelen. De lamp alleen binnen gebruiken.

1 arm

3 arms

5 arms

mm

min. 1200 - max. 1500

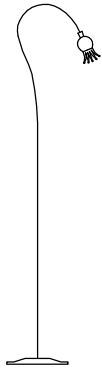

Ø 240

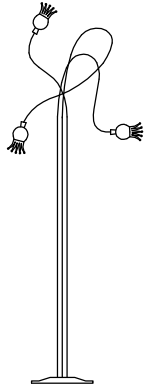

Ø 240

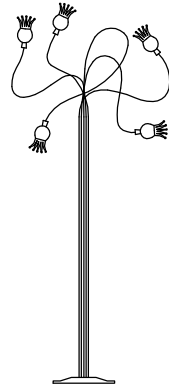

Ø 240

kg

5,80

6,80

7,80



1 x 35 W
G4 12 V



3 x 35 W
G4 12 V



5 x 20 W
G4 12 V

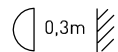

0,3m



01

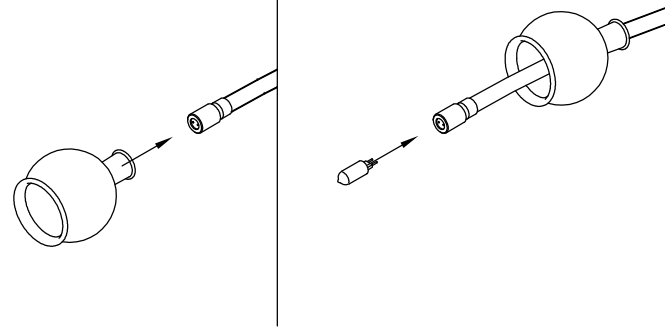

02

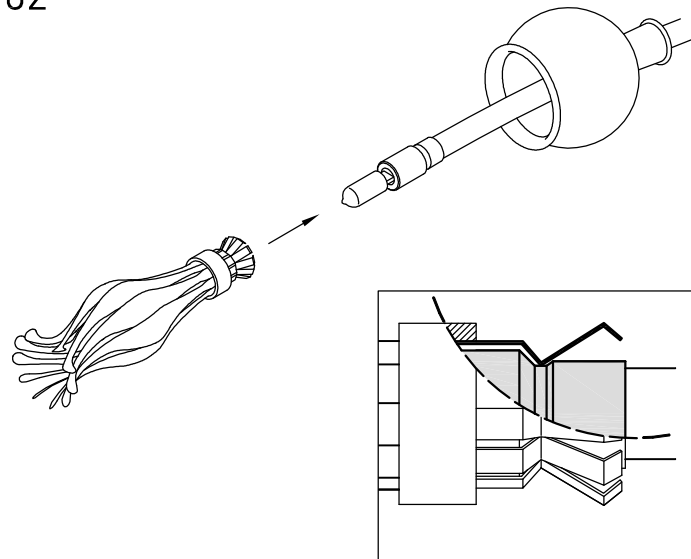

03

